

Outdoor Air Conditioner

User's Information and Installation Instructions

14 SEER R-410A High Efficiency Split System

These units have been designed and tested for capacity and efficiency in accordance with A.R.I. Standards. Split System Air Conditioning units are designed for use with a wide variety of fossil fuel furnaces, electric furnaces, air handlers, and evaporator coil combinations.

These instructions are primarily intended to assist qualified individuals experienced in the proper installation of heating and/or air conditioning appliances. Some local codes require licensed installation/service personnel for this type of equipment. Read all instructions carefully before starting the installation.

USER'S INFORMATION

IMPORTANT

Read this owner information to become familiar with the capabilities and use of your appliance. Keep this with literature on other appliances where you have easy access to it in the future. If a problem occurs, check the instructions and follow recommendations given. If these suggestions don't eliminate your problem, call your servicing contractor .

OPERATING INSTRUCTIONS

To Operate Your Air Conditioner for Cooling —

1. Set the thermostat system switch to COOL or AUTO and the thermostat fan switch to AUTO. (See Figure 1)
2. Set the thermostat temperature to the desired temperature level by pressing the WARMER or COOLER button. Please refer to the separate detailed thermostat user's manual for complete instructions regarding thermostat programming. The outdoor unit and indoor blower will both cycle on and off to maintain the indoor temperature at the desired cooling level.

To Operate Your Furnace for Heating —

1. Set the thermostat system switch to HEAT or AUTO and the thermostat fan switch to AUTO. (See Figure 1)
2. Set the thermostat temperature to the desired temperature level by pressing the WARMER or COOLER button. Please refer to the separate detailed user's manual for complete thermostat programming instructions. The furnace and indoor blower will cycle on and off to maintain the indoor temperature at the desired heating level.

To Shut Off Your Air Conditioner —

Set the thermostat system switch to OFF and the thermostat fan switch to AUTO. (See Figure 1)

The system will not operate, regardless of the thermostat temperature setting.

To Operate the Indoor Blower Continuously —

Set the thermostat fan switch to ON. (See Figure 1)

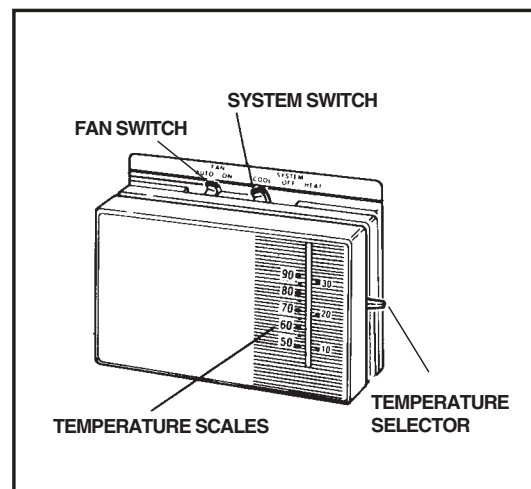

Figure 1. Typical Thermostat

The indoor blower will start immediately, and will run continually until the fan switch is reset to AUTO.

The continuous indoor blower operation can be obtained with the thermostat system switch set in any position, including OFF.

The continuous indoor blower operation is typically used to circulate the indoor air to equalize a temperature unbalance due to a sun load, cooking, or fireplace operation.

To Maintain Your Air Conditioner —

CAUTION:

Be certain the electrical power to the outdoor unit and the furnace/air handler is disconnected before doing the following recommended maintenance.

1. Regularly:

- a. Clean or replace the indoor air filter at the start of each heating and cooling season, and when an accumulation of dust and dirt is visible on the air filter.
- b. Remove any leaves and grass clippings from the coil in the outdoor unit, being careful not to damage the aluminum fins.
- c. Check for any obstruction, such as twigs, sticks, etc.

2. Before Each Cooling Season:

If the furnace/air handler blower motor and the outdoor unit fan motor(s) have oil tubes at the motor bearings, apply 10 drops of SAE No. 20 motor oil to each oil tube.

CAUTION:

Do not over-oil, or oil motors not factory-equipped with oil tubes. The compressor is hermetically “sealed” and does not require lubrication.

3. Before Calling a Service Technician, Be Certain:

- a. The unit thermostat is properly set — see “To Operate Your Air Conditioner for Cooling” and “To Operate Your Furnace for Heating.”
- b. The unit disconnect fuses are in good condition, and the electrical power to the unit is turned on.

1. GENERAL INFORMATION

Read the following instructions completely before performing the installation.

CAUTION:

This unit uses refrigerant R-410A. DO NOT under any circumstances use any other refrigerant besides R-410A in this unit. Use of another refrigerant will damage this unit.

Condensing Unit Section — Each condensing unit is shipped with a refrigerant charge adequate to operate the outdoor section with an indoor matching coil or air handler, and 15 feet of refrigeration line.

NOTE: DO NOT USE ANY PORTION OF THE CHARGE FOR PURGING OR LEAK TESTING.

Matching coils and air handlers are shipped with a small pressurized holding charge to pressurize them to keep out contaminants. To release the pressure, read the indoor section installation instructions carefully.

Liquid and Suction Lines — Refrigerant grade copper tubing should be used when installing the system. Refrigerant suction line tubing should be fully insulated.

Field Connections for Electrical Power Supply — All wiring must comply with current provisions of the “National Electrical Code” (ANSI C1.) and with applicable local codes having jurisdiction. The minimum size of electrical conductors and circuit protection must be in compliance with information listed on the outdoor unit data label.

NOTICE:

Certain models have external panels fabricated from a premium grade of stainless steel designed to inhibit corrosion. For such units, if the unit is located in a coastal region or other area subjected to high concentrations of salt, then the unit should be hosed off after storms and monthly otherwise to maintain its new appearance.

2. SAFETY CONSIDERATIONS

Pressures within the System — Split system air conditioning equipment contains liquid and gaseous refrigerant under pressure. Installation and servicing of this equipment should be accomplished by qualified, trained personnel thoroughly familiar with this type of equipment. Under no circumstances should the Homeowner attempt to install and/or service the equipment.

Labels, Tags, Precautions — When working with this equipment, follow all precautions in the literature, on tags, and on labels provided with the equipment. Read and thoroughly understand the instructions provided with the equipment prior to performing the installation and operational checkout of the equipment.

Brazing Operations — Installation of equipment may require brazing operations. Safety codes must be complied with. Safety equipment (e.g.; safety glasses, work gloves, fire extinguisher, etc.) must be used when performing brazing operations.

WARNING:

Ensure all electrical power to the unit is off prior to installing or servicing the equipment. Failure to do so may cause personal injury or death.

3. SITE PREPARATION

Unpacking Equipment — Remove the cardboard carton and User's Manual from the equipment. Take care not to damage the tubing connections when removing the carton.

Inspect for Damage — Inspect the equipment for damage prior to installing the equipment at

the job site. Ensure coil fins are straight and, if necessary, comb fins to remove flattened and bent fins.

Preferred Location of the Outdoor Unit at the Job Site — Conduct a survey of the job site to determine the optimum location for mounting the outdoor unit. Overhead obstructions, poorly ventilated areas, and areas subject to accumulation of debris should be avoided. The outdoor unit should be installed no closer than 18 inches from the outside walls of the facility and in an area free from overhead obstructions to ensure unrestricted airflow through the outdoor unit.

Facility Prerequisites — Electrical power must be supplied to the equipment. Electrical power supplied must be adequate for proper operation of the equipment. The system must be wired and provided with circuit protection in accordance with local building codes and the National Electrical Code.

4. INSTALLING THE OUTDOOR UNIT

Slab Mount — The site selected for a slab mount installation requires a stable foundation and one not subject to erosion. The slab should be level and anchored (if necessary) prior to placing the equipment on the slab.

Cantilever Mount — The cantilever mount should be designed with adequate safety factor to support the weight of the equipment, and for loads subjected to the mount during operation. Installed equipment should be adequately secured to the cantilever mount and levelled prior to operation of the equipment.

Roof Mount — The method of mounting should be designed so as not to overload roof structures nor transmit noise to the interior of the structure. Refrigerant and electrical line should be routed through suitably waterproofed openings to prevent water leaking into the structure.

5. INSTALLING THE INDOOR UNIT

The indoor section should be installed before proceeding with routing of refrigerant piping. Consult the installation instructions of the indoor unit (i.e.: air handler, furnace, etc.) for details regarding installation.

6. CONNECTING REFRIGERANT TUBING BETWEEN THE INDOOR AND OUTDOOR UNIT

**CAUTION:**

This system utilizes R-410A refrigerant with POE oil. When servicing, cover or seal openings to minimize the exposure of the refrigerant system to air to prevent accumulation of moisture and other contaminants.

General — Once outdoor and indoor unit placement has been determined, route refrigerant tubing between the equipment in accordance with sound installation practices. Refrigerant tubing should be routed in a manner that minimizes the length of tubing and the number of bends in the tubing. Refrigerant tubing should be supported in a manner that the tubing will not vibrate or abrade during system operation. Tubing should be kept clean of foreign debris during installation and installation of a liquid line filter drier is recommended if cleanliness or adequacy of system evacuation is unknown or compromised. Every effort should be made by the installer to ensure that the field installed refrigerant containing components of the system have been installed in accordance with these instructions and sound installation practices so as to insure reliable system operation and longevity. The maximum recommended interconnecting refrigerant line length is 75 feet, and the vertical elevation difference between the indoor and outdoor sections should not exceed 20 feet. Consult long line application guide for installations in excess of these limits.

Filter Dryer Installation—A filter dryer is provided with the unit and must be installed in the liquid line of the system. If the installation replaces a system with a filter dryer already present in the liquid line, the filter dryer must be replaced with the one supplied. The filter dryer must be installed in strict accordance with the manufacturer's installation instructions.

Optional Equipment — Optional equipment (e.g.: filter/driers, liquid line solenoid valves, etc.) should be installed in strict accordance with the manufacturer's installation instructions.

7. MAKING ELECTRICAL CONNECTIONS

**WARNING:**

Turn off all electrical power at the main circuit box before wiring electrical power to the outdoor unit. Failure to comply may cause severe personnel injury or death.

Wiring Diagram/Schematic — A wiring diagram/schematic is located on the inside cover of the electrical box of the outdoor unit. The installer should become familiar with the wiring diagram/schematic before making any electrical connections to the outdoor unit.

Outdoor Unit Connections — The outdoor unit requires both power and control circuit electrical connections. Refer to the unit wiring diagram/schematic for identification and location of outdoor unit field wiring interfaces.

Control Circuit Wiring — The outdoor unit is designed to operate from a 24 VAC Class II control circuit. Control circuit wiring must comply with the current provisions of the "National Electrical Code" (ANSI C1.) and with applicable local codes having jurisdiction.

Thermostat Connections — Thermostat connections should be made in accordance with the instructions supplied with the thermostat, and with the instructions supplied with the indoor equipment.

Electrical Power Wiring — Electrical power wiring shall comply with the current provisions of the "National Electrical Code" (ANSI C1.) and with applicable local codes having jurisdiction. Use of rain tight conduit is recommended. Electrical conductors shall have minimum circuit ampacity in compliance with the outdoor unit rating label. The facility shall employ electrical circuit protection at a current rating no greater than that indicated on the outdoor unit rating label.

Minimum Circuit Ampacity — Electrical wiring to the equipment must be compatible and in compliance with the minimum circuit ampacity listed on the outdoor unit data label.

Maximum Fuse/Circuit Breaker Size — Circuit protection for the outdoor unit must be compatible with the maximum fuse/circuit breaker size listed on the outdoor unit data label.

COPPER WIRE SIZE — AWG (1% Voltage Drop)				
Supply Wire Length-Feet				Supply Circuit Ampacity
200	150	100	50	
6	8	10	14	15
4	6	8	12	20
4	6	8	10	25
4	4	6	10	30
3	4	6	8	35
3	4	6	8	40
2	3	4	6	45
2	3	4	6	50

Wire Size based on N.E.C. for 60° type copper conductors.

Disconnect Switch — An electrically compatible disconnect switch must be within line of sight of the outdoor unit. This switch shall be capable of electrically de-energizing the outdoor unit.

Optional Equipment — Optional equipment requiring connection to the power or control circuits must be wired in strict accordance with current provisions of the “National Electrical Code” (ANSI C1.), with applicable local codes having jurisdiction, and the installation instructions provided with the equipment. Optional Equipment (e.g.: liquid line solenoid valves, hard start kits, low suction pressure cutout switch kit, high pressure cutout switch kit, refrigerant compressor crankcase heater, etc.) should be installed in strict accordance with the manufacturer’s installation instructions.

8. STARTUP AND CHECKOUT

WARNING:

Ensure electrical power to the unit is off prior to performing the following steps. Failure to do so may cause personal injury or death.

Air Filters — Ensure air filters are clean and in place prior to operating the equipment.

Thermostat — Set the room thermostat function switch to OFF, fan switch to AUTO, and move temperature setpoint to its highest setting. Prior to applying electrical power to the outdoor unit, ensure that the unit has been properly and securely grounded, and that power supply connections have been made at both the facility power interface and outdoor unit.

Outdoor Unit — Ensure the outdoor coil and top of the unit are free from obstructions and debris, and all equipment access/control panels are in place.

Using extreme caution, apply power to the unit and inspect the wiring for evidence of open, shorted, and/or improperly wired circuits.

Functional Checkout:

CAUTION:

If equipped with a compressor crankcase heater, wait 24 hours prior to performing a function checkout to allow for heating of the compressor crankcase. Failure to comply may result in damage and could cause premature failure of the system.

Indoor Blower — Set the thermostat function switch to COOLING and the fan switch to ON. Verify that the indoor blower is operating and that airflow is not restricted. Set the fan switch back to AUTO.

Blower Time Delay Relay (Select Models): A time delay relay may be provided with the unit and must be installed in the indoor section. The relay will keep the indoor blower running an additional 40 seconds for increased cooling efficiency after the outdoor unit shuts off. The relay has four terminals and one mounting hole. Connect terminal “1” to load side of blower relay. Connect terminal “2” to terminal “R” of T’stat. Connect terminal “3” to common terminal at blower relay or transformer. Connect terminal “4” to terminal “G” on T’stat.

Low-Pressure Switch—(Select Models) A low-pressure switch is factory-installed and located in the suction line internal to the outdoor unit. The switch is designed to protect the compressor from a loss of charge. Under normal conditions, the switch is closed. If the suction pressure falls below 5 psig, then the switch will open and de-energize the outdoor unit. The switch will close again once the suction pressure increases above 20 psig. Please note that the switch interrupts the thermostat inputs to the unit. Thus when the switch opens and then closes, there will be a 5 minute short cycling delay before the outdoor unit will energize.

High-Pressure Switch—A High-pressure switch is factory-installed and located in the compressor discharge line internal to the outdoor unit. The switch is designed to de-energize the system when very high pressures occur during abnormal conditions. Under normal conditions, the switch is closed. If the discharge pressure rises above 575 psig, then the switch will open and de-energize the outdoor unit. The switch will close again once the discharge pressure decreases to 460 psig. Please note that the switch interrupts the thermostat inputs to the unit. Thus, when the switch opens and then closes, there will be a 5 minute short cycling delay before the outdoor unit will energize.

Comfort Alert™ Diagnostics (Select Models) — The Comfort Alert™ diagnostics module facilitates troubleshooting heat pump and air conditioning system failures. This Comfort Alert™ module is designed only for single-phase systems with scroll compressors that have internal overload protection. By monitoring and analyzing data from the compressor and the thermostat demand, the module can detect the cause of electrical and system related failures without any sensors. A flashing LED indicator communicates the ALERT code and guides the service technician more quickly and accurately to the root cause of a problem.

NOTE: This module does not provide safety protection! The Comfort Alert™ module is a monitoring device and cannot control or shut down other devices.

LED Description (See Figure 2)

POWERLED (Green): indicates voltage is present at the power connection of the module.

ALERT LED (Yellow): communicates an abnormal system condition through a unique flash code. The ALERT LED will flash a number of times consecutively, pause and then repeat the process. The number of consecutive flashes, defined as the Flash Code, correlates to a particular abnormal condition. Detailed descriptions of specific ALERT Flash Codes are shown in Table 1 of this manual.

TRIP LED (Red): indicates there is a demand signal from the thermostat but no current to the compressor is detected by the module. The TRIP LED typically indicates the compressor protector is open or may indicate missing supply power to the compressor.

The scroll compressor's run (R), common (C) and start (S) wires are routed through the holes in the Comfort Alert™ module marked "R," "C" and "S."

24 VAC Power Wiring — The Comfort Alert™ module requires a constant nominal 24 VAC power supply. The wiring to the module's R and C terminals must be directly from the indoor unit or thermostat.

The Comfort Alert™ module requires a thermostat demand signal to operate properly.

NOTE: After the thermostat demand signal is connected, verify that 24 VAC across Y and C when demand is present.

TROUBLESHOOTING

Interpreting The Diagnostic LEDs – When an abnormal system condition occurs, the Comfort Alert™ module displays the appropriate ALERT and/or TRIP LED will flash a number of times consecutively, pause and then repeat the process. To identify a Flash Code number, count the number of consecutive flashes.

Every time the module powers up, the last ALERT Flash Code that occurred prior to shut down is displayed for one minute. The module will continue to display the LED until the condition returns to normal or if 24 VAC power is removed from the module.

Cooling — Gradually lower the thermostat temperature setpoint below the actual room temperature and observe that the outdoor unit and indoor blower energize. Feel the air being

circulated by the indoor blower and verify that it is cooler than ambient temperature. Listen for any unusual noises. If present, locate and determine the source of the noise and correct as necessary.

Heating — If provided with heating equipment, lower the thermostat setpoint temperature to the lowest obtainable setting and set the thermostat function switch to HEATING. The indoor blower and outdoor unit should stop running. Increase the setpoint temperature of the thermostat to the maximum setting. Verify that the heating equipment has been energized (i.e., fossil fuel burner operating, etc.) and that the indoor blower

energizes after a short period of time. Feel the air being circulated by the indoor blower and verify that it is warmer than ambient temperature. Listen for any unusual noises. If present, locate and determine the source of the noise and correct as necessary.

NOTE: Other sources for heating (i.e.: electric furnace, fossil fuel furnace, air handler with electric heat options, etc.) that interface with the unit should be functionally checked to verify system operation and compatibility. Refer to the installation instructions for this equipment and perform a functional checkout in accordance with the manufacturer's instructions.

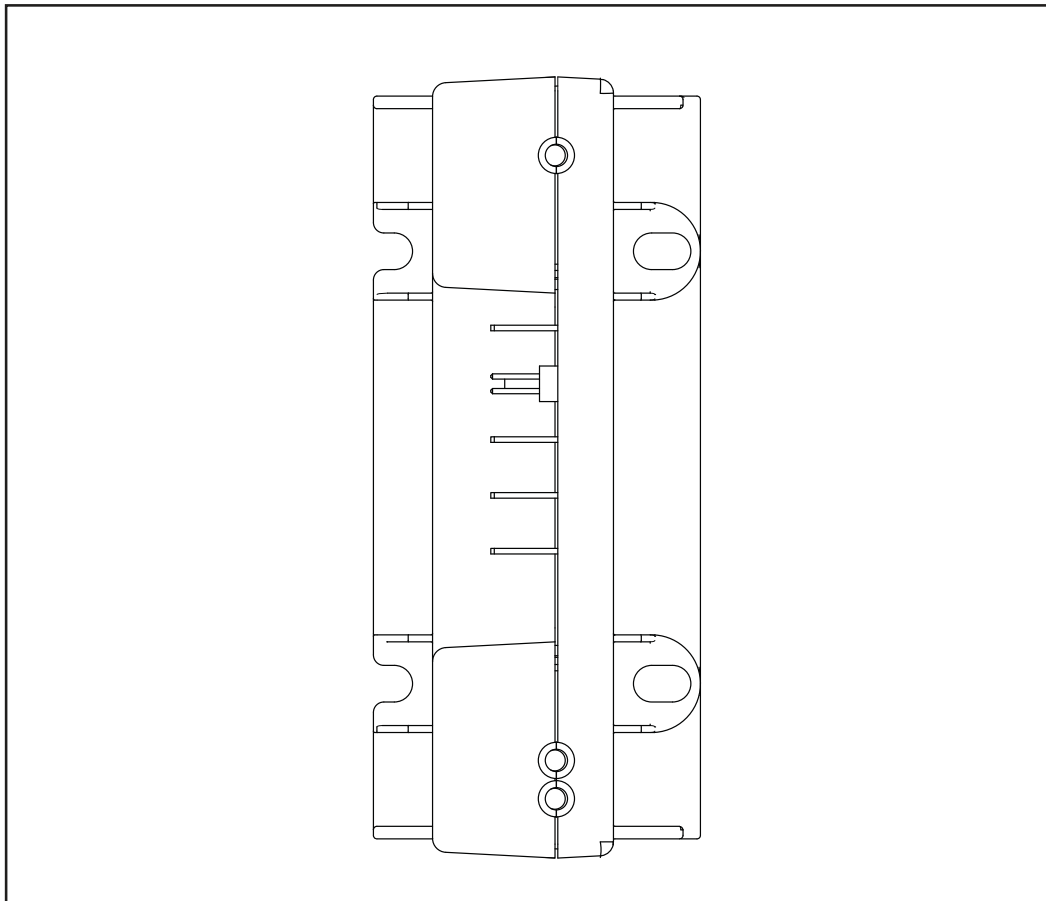

**Figure 2. Comfort Alert™
Diagnostics Module**

Status LED	Status LED Description	Status LED Troubleshooting Information
Green "POWER"	Module has power	Supply voltage is present at module terminals
Red "TRIP"	Thermostat demand signal Y is present, but the compressor is not running	<ol style="list-style-type: none"> 1. Compressor protector is open 2. Outdoor unit power disconnect is open 3. Compressor circuit breaker or fuse(s) is open 4. Broken wire or connector is not making contact 5. Low pressure switch open if present in system 6. Compressor contactor has failed open
Yellow "ALERT" Flash Code 1	Long Run Time Compressor is running extremely long run cycles	<ol style="list-style-type: none"> 1. Low refrigerant charge 2. Evaporator blower is not running 3. Evaporator coil is frozen 4. Faulty metering device 5. Condenser coil is dirty 6. Liquid line restriction (filter drier blocked if present in system) 7. Thermostat is malfunctioning 8. Comfort Alert Failure 9. Comfort Alert Failure
Yellow "ALERT" Flash Code 2	System Pressure Trip Discharge or suction pressure out of limits or compressor overloaded	<ol style="list-style-type: none"> 1. High head pressure 2. Condenser coil poor air circulation (dirty, blocked, damaged) 3. Condenser fan is not running 4. Return air duct has substantial leakage 5. If low pressure switch present in system, check Flash Code 1 information
Yellow "ALERT" Flash Code 3	Short Cycling Compressor is running only briefly	<ol style="list-style-type: none"> 1. Thermostat demand signal is intermittent 2. Time delay relay or control board defective 3. If high pressure switch present go to Flash Code 2 information 4. If low pressure switch present go to Flash Code 1 information
Yellow "ALERT" Flash Code 4	Locked Rotor	<ol style="list-style-type: none"> 1. Run capacitor has failed 2. Low line voltage (contact utility if voltage at disconnect is low) <ul style="list-style-type: none"> • Check wiring connections 3. Excessive liquid refrigerant in compressor 4. Compressor bearings are seized <ul style="list-style-type: none"> • Measure compressor oil level
Yellow "ALERT" Flash Code 5	Open Circuit	<ol style="list-style-type: none"> 1. Outdoor unit power disconnect is open 2. Compressor circuit breaker or fuse(s) is open 3. Compressor contactor has failed open <ul style="list-style-type: none"> • Check compressor contactor wiring and connectors • Check for compressor contactor failure (burned, pitted or open) • Check wiring and connectors between supply and compressor • Check for low pilot voltage at compressor contactor coil 4. High pressure switch is open and requires manual reset 5. Open circuit in compressor supply wiring or connections 6. Unusually long compressor protector reset time due to extreme ambient temperature 7. Compressor windings are damaged <ul style="list-style-type: none"> • Check compressor motor winding resistance
Yellow "ALERT" Flash Code 6	Open Start Circuit Current only in run circuit	<ol style="list-style-type: none"> 1. Run capacitor has failed 2. Open circuit in compressor start wiring or connections <ul style="list-style-type: none"> • Check wiring and connectors between supply and the compressor "S" terminal 3. Compressor start winding is damaged <ul style="list-style-type: none"> • Check compressor motor winding resistance
Yellow "ALERT" Flash Code 7	Open Run Circuit Current only in start circuit	<ol style="list-style-type: none"> 1. Open circuit in compressor run wiring or connections <ul style="list-style-type: none"> • Check wiring and connectors between supply and the compressor "R" terminal 2. Compressor run winding is damaged <ul style="list-style-type: none"> • Check compressor motor winding resistance
Yellow "ALERT" Flash Code 8	Welded Contactor Compressor always runs	<ol style="list-style-type: none"> 1. Compressor contactor has failed closed 2. Thermostat demand signal not connected to module
Yellow "ALERT" Flash Code 9	Low Voltage Control circuit < 17VAC	<ol style="list-style-type: none"> 1. Control circuit transformer is overloaded 2. Low line voltage (contact utility if voltage at disconnect is low) <ul style="list-style-type: none"> • Check wiring connections

- Flash Code number corresponds to a number of LED flashes, followed by a pause and then repeated.
- TRIP and ALERT LEDs flashing at same time means control circuit voltage is too low for operation.

Table 1. Interpreting the Diagnostic LEDs

Miswired Module Indication	Recommended Troubleshooting Action
Green LED is not on, module does not power up	Determine if both R and C module terminals are connected. Verify voltage is present at module's R and C terminals. Review 24VAC Power Wiring (page 4) for R and C wiring.
Green LED intermittent, module powers up only when compressor runs	Determine if R and Y terminals are wired in reverse. Verify module's R and C terminals have a constant source. Review 24VAC Power Wiring (page 4) for R and C wiring.
TRIP LED is on but system and compressor check OK	Verify Y terminal is connected to 24VAC at contactor coil. Verify voltage at contactor coil falls below 0.5VAC when off.
TRIP LED and ALERT LED flashing together	Verify R and C terminals are supplied with 19-28VAC.
ALERT Flash Code 3 (Compressor Short Cycling) displayed incorrectly	Verify Y terminal is connected to 24VAC at contactor coil. Verify voltage at contactor coil falls below 0.5VAC when off.
ALERT Flash Code 5, 6 or 7 (Open Circuit, Open Start Circuit or Open Run Circuit) displayed incorrectly	Check that compressor run and start wires are through module's current sensing holes. Verify Y terminal is connected to 24VAC at contactor coil. Verify voltage at contactor coil falls below 0.5VAC when off.
ALERT Flash Code 6 (Open Start Circuit) displayed for Code 7 (Open Run Circuit) or vice versa	Check that compressor run and start wires are routed through the correct module sensing holes.
ALERT Flash Code 8 (Welded Contactor) displayed incorrectly	Determine if module's Y terminal is connected. Verify Y terminal is connected to 24VAC at contactor coil. Verify 24VAC is present across Y and C when thermostat demand signal is present. If not, R and C are reverse wired. Verify voltage at contactor coil falls below 0.5VAC when off.

Table 2. Module Wiring Troubleshooting

Adjustment of Refrigerant Charge:



CAUTION:

Split system air conditioner equipment contains liquid and gaseous refrigerant under pressure. Adjustment of refrigerant charge should only be attempted by qualified, trained personnel thoroughly familiar with the equipment. Under no circumstances should the homeowner attempt to install and/or service this equipment. Failure to comply with this warning could result in equipment damage, personal injury, or death.

NOTE: The following Refrigerant Charging Charts are applicable to matched assemblies of our equipment and at listed airflows for the indoor coil. These units are matched with TXV equipped indoor coils. Assemblies of indoor coils and outdoor units not listed are not recommended and deviations from rated airflows or non-listed equipment combinations may require modifications to the expansion device(s) and refrigerant charging procedures for proper and efficient system operation.

Refrigerant Charging Chart — Refer to Refrigerant Charging Charts for correct system charging.

Optional Equipment — A functional checkout should be performed in accordance with the checkout procedures supplied with the equipment.

Refrigerant Charging Charts For Cooling Mode of Operation

S4BE-018K

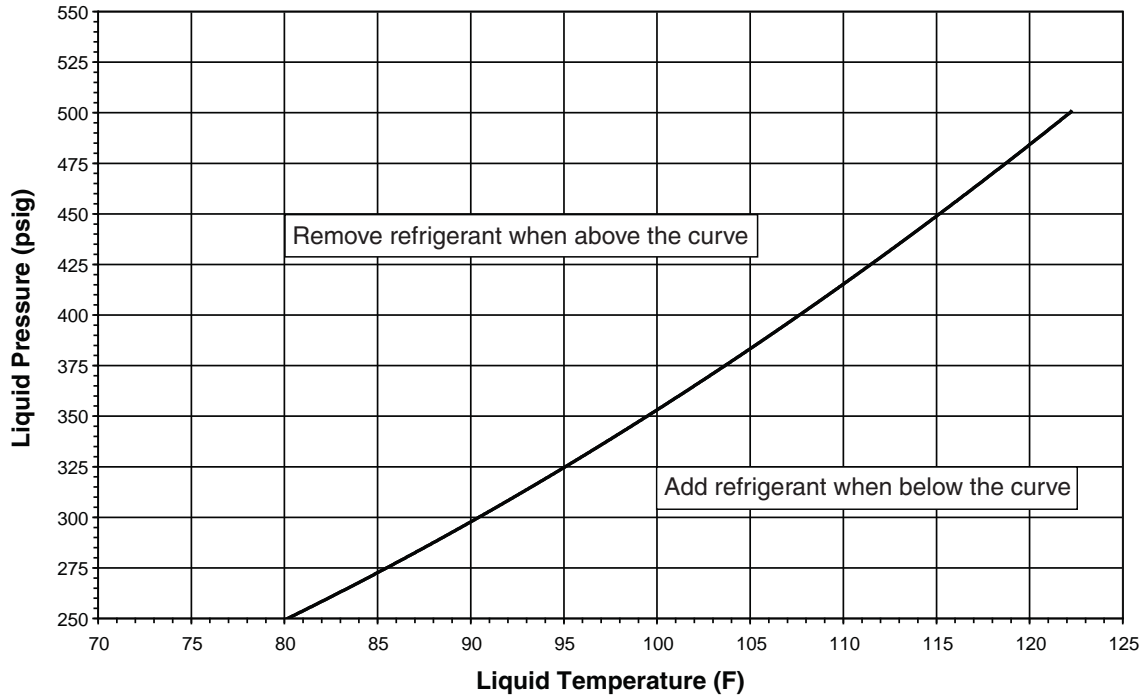

S4BE-024K

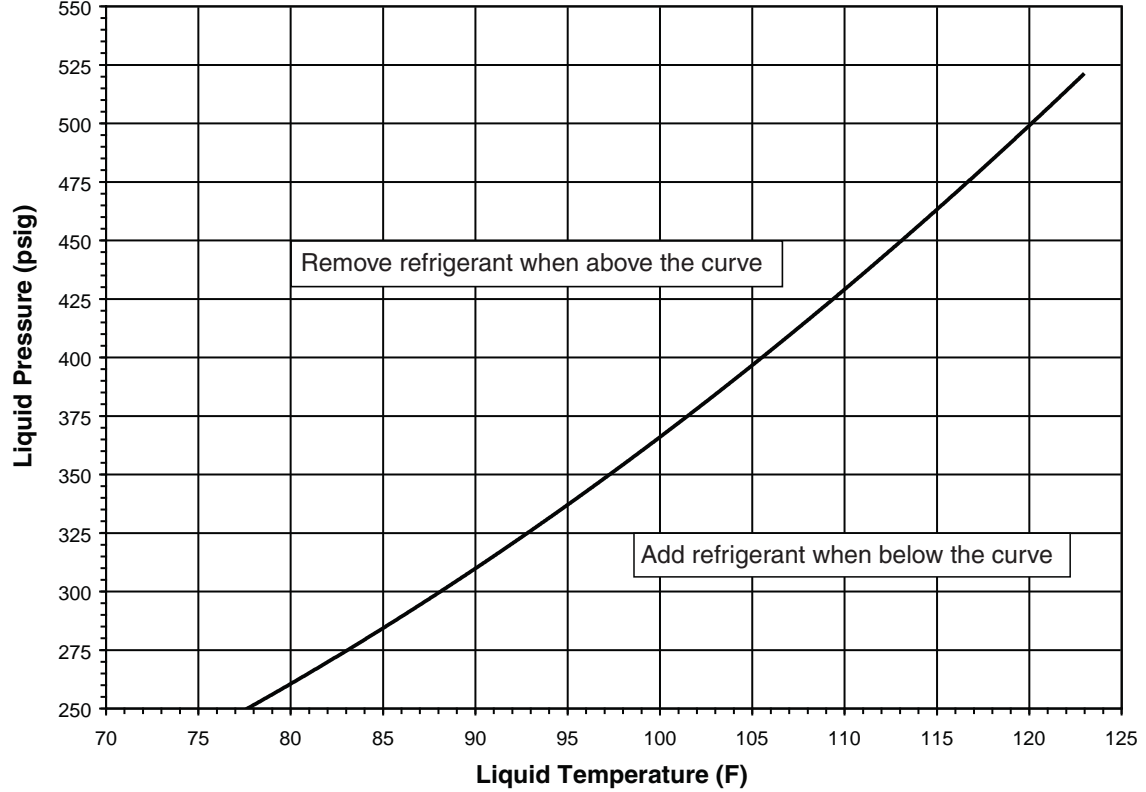

*Note: All pressures are listed in psig, and all temperatures in deg. F.

Refrigerant Charging Charts For Cooling Mode of Operation (Continued)

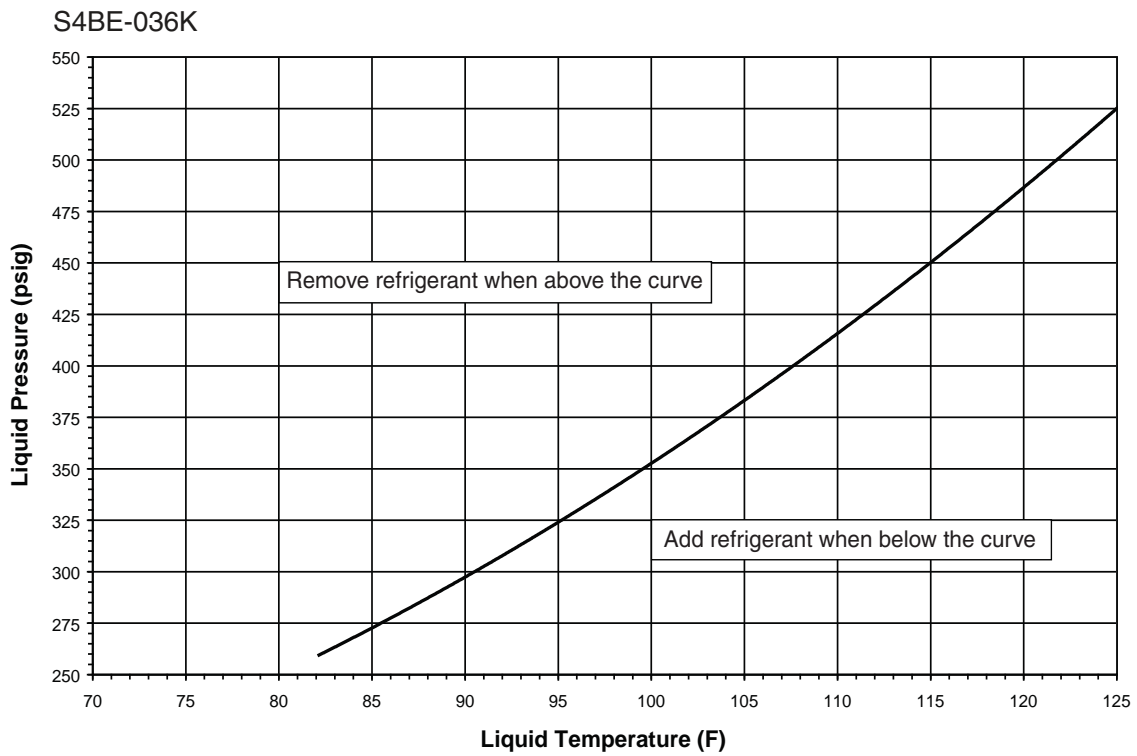
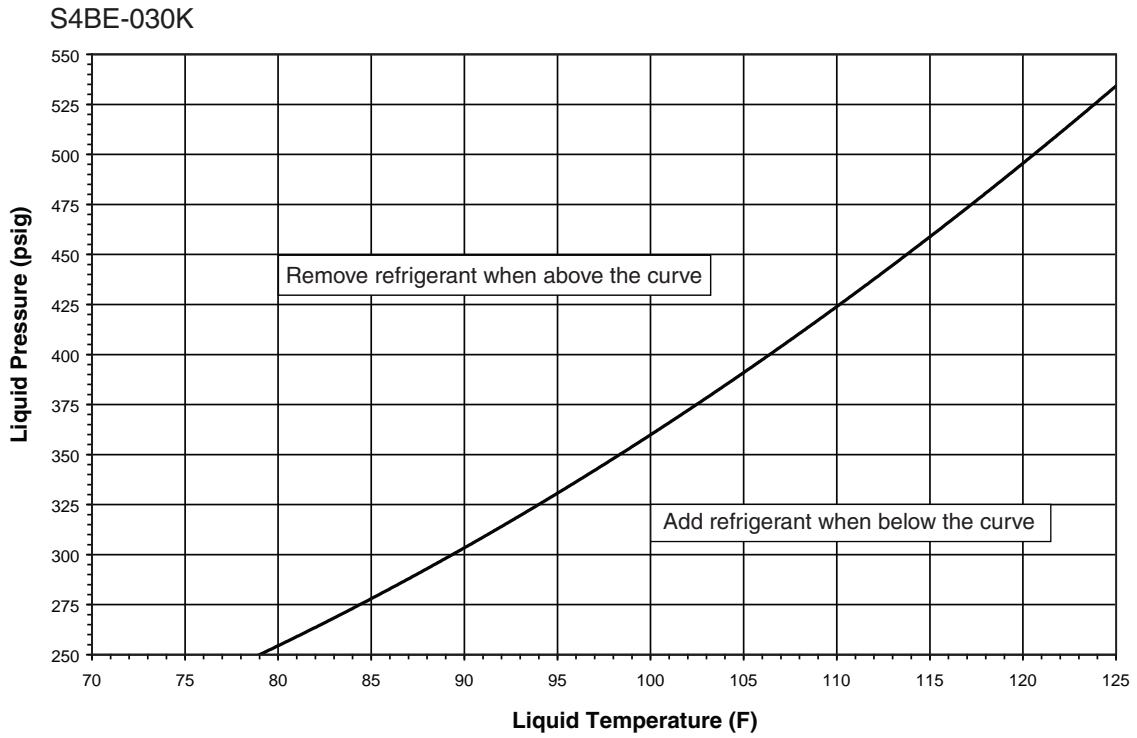

*Note: All pressures are listed in psig. and all temperatures in deg. F.

Refrigerant Charging Charts For Cooling Mode of Operation (Continued)

S4BE-042K

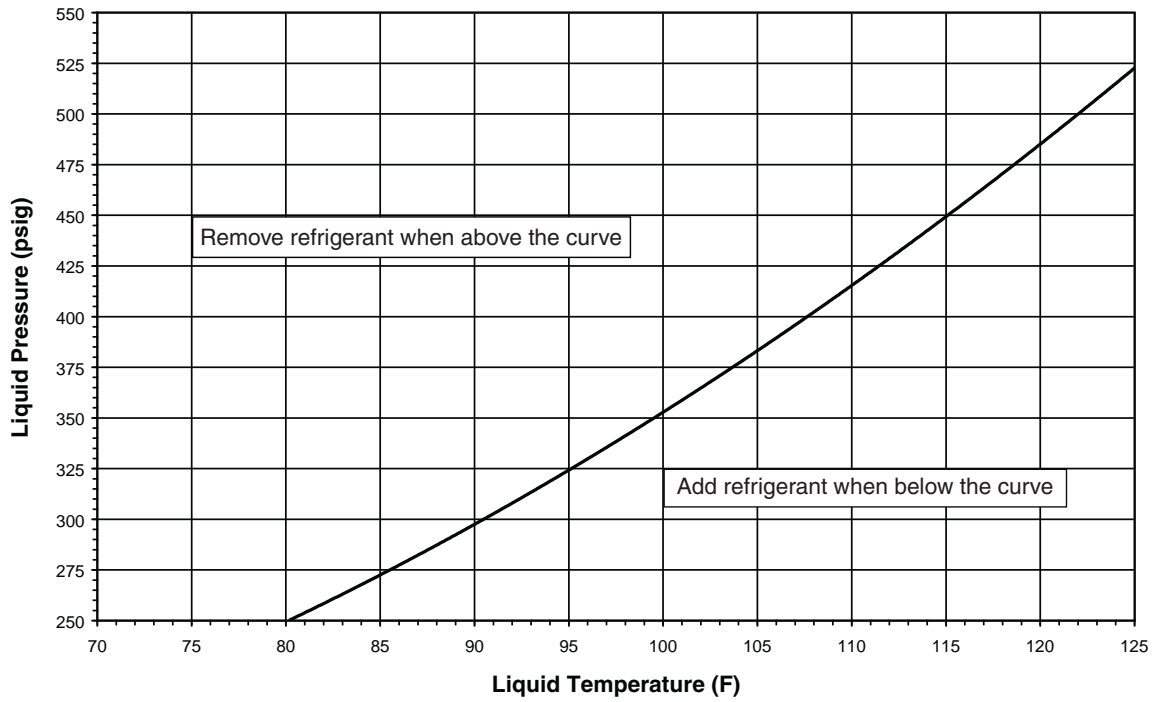

S4BE-048K

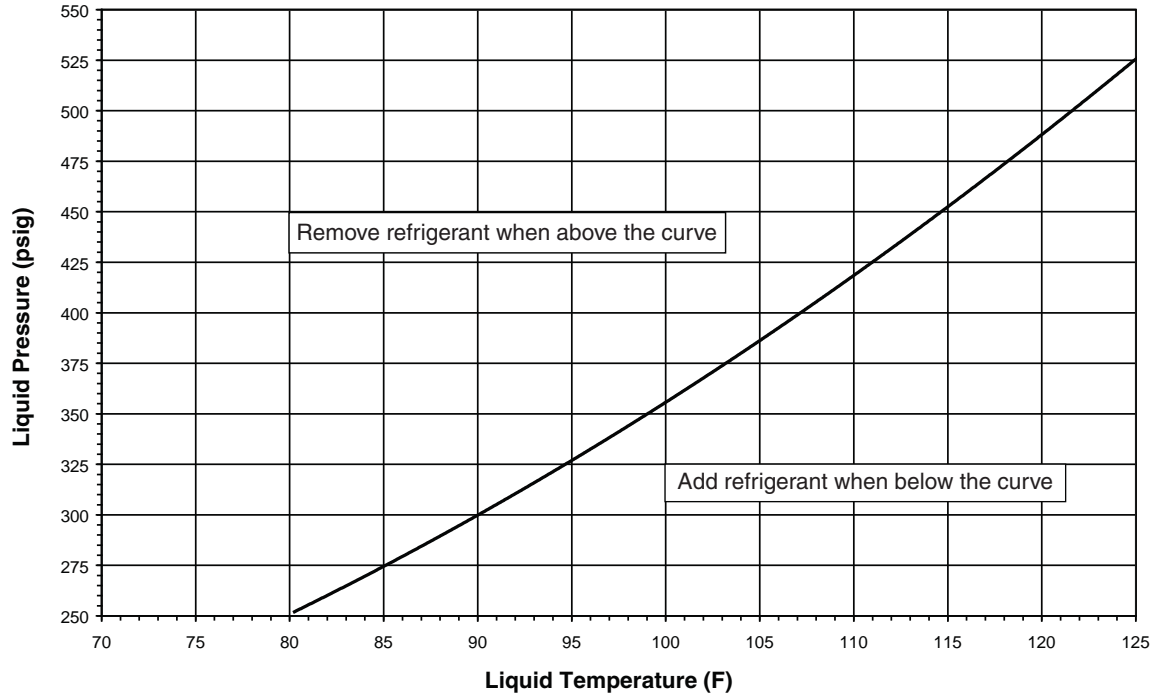

*Note: All pressures are listed in psig. and all temperatures in deg. F.

Refrigerant Charging Charts For Cooling Mode of Operation (Continued)

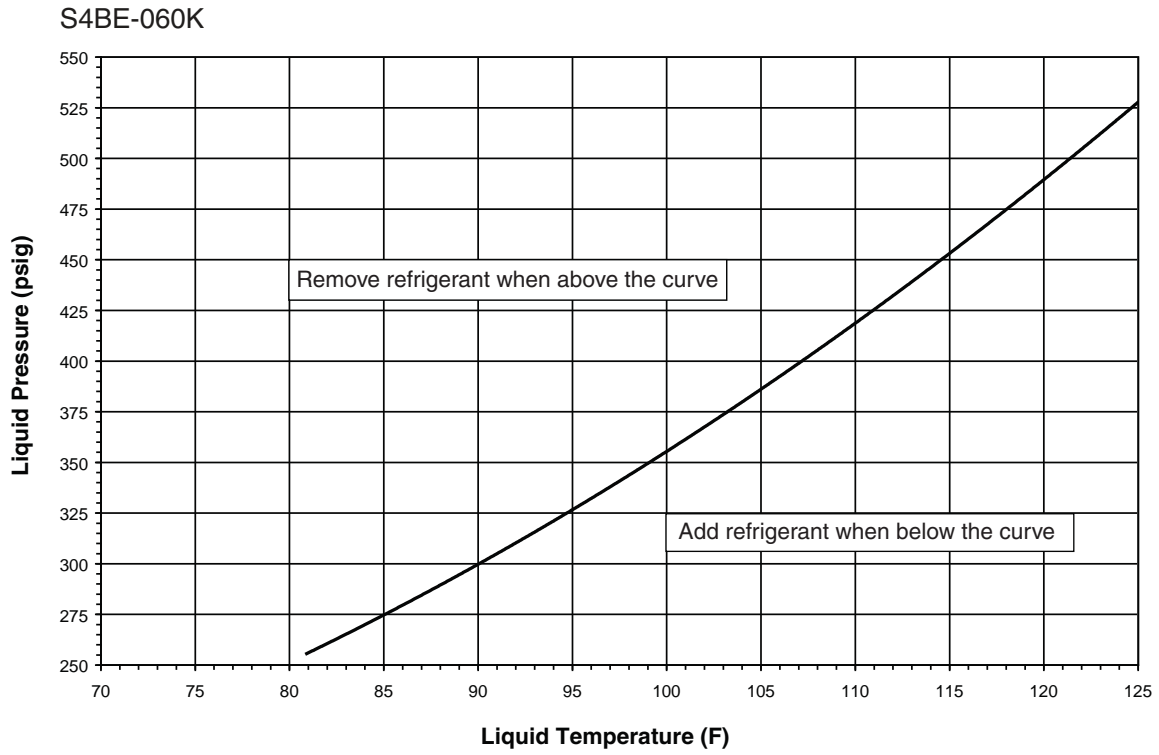

*Note: All pressures are listed in psig. and all temperatures in deg. F.



**INSTALLER: PLEASE LEAVE THESE
INSTALLATION INSTRUCTIONS
WITH THE HOMEOWNER**



¢708665Hα

7086650

7086650
Specifications and illustrations subject to change
without notice and without incurring obligations.
Printed in U.S.A. (11/06)