

TECHNICAL SPECIFICATIONS

MG2R Series

High Efficiency / Direct Vent Condensing Downflow Gas Furnace Induced Draft - 95% AFUE Input 45,000 thru 72,000 Btuh

The high efficiency downflow gas furnace is designed for all manufactured housing applications. It may be installed in a utility room, or enclosed in a closet. CSA design certified for use in the United States and Canada.



Front Return Models



Top Return Models

For California installations in SCAQMD only: This furnace does not meet the SCAQMD Rule 1111 NO_x emission limit (14 ng/J), and thus is subject to a mitigation fee of up to \$450. This furnace is not eligible for the Clean Air Furnace Rebate Program: www.CleanAirFurnaceRebate.com.

FEATURES and BENEFITS

- **100% fired and tested:** All units and each component (both mechanical and electrical) are tested on the manufacturing line.
- **Clean and quiet operation:** Due to the unique design of in-shot burners, location of inducer and use of insulation.
- **Fixed 30 second blower delay:** At burner start-up assures a warm outlet air temperature at furnace start-up. Adjustable blower off settings (60, 90, 120 and 180 seconds).
- **Fixed 30-second post purge:** Increases life of heat exchanger.
- **Dependable, hot surface ignitor:** Innovative application of silicon nitride type igniter. Utilizes proven Smartlite® technology to extend igniter life.
- **Tubular primary heat exchanger:** Heavy gauge aluminized steel heat exchanger assures a long life.
- **Stainless steel secondary heat exchanger:** Assures a long life.
- **60 second fixed cooling cycle blower-off delay (TDR):** Increases cooling performance when matched with a Nortek Global HVAC coil.
- **Sealed combustion approved for direct vent furnace, category IV venting system:** May be vertically or horizontally vented using a two-pipe system for maximum flexibility in installation.
- **LP convertible:** Simple burner orifice (included w/unit) and gas valve regulator change for ease of convertibility.
- **3 amp fuse protection against low voltage shorts:** Protects transformer and control board.
- **Low voltage terminal board:** For easy field wiring.
- **Easy open pawl latch:** Secures the door firmly for transit, yet allows easy removal for access.
- **Appliance quality door:** Protects against rust and other corrosion. Baked enamel finish allows for easy cleaning.
- **Color coded wire harness:** Designed to fit the components, all with quick-connect fittings for ease of service and replacement.
- **Multi-speed ECM blower:** Designed to give a wide range of cooling capacities. Switches on PCB, provide ultra easy motor speed selection. 40VA transformer included.
- **Diagnostic lights for easy troubleshooting without counting flashes:** Dedicated light for flame signal strength and 2 lights in combination to indicate all other fault codes with easy to recognize states without counting flashes.

Note: The MG2R will fit in the same footprint and uses the same duct connector as the M1, M3, M7 and MG1E furnaces; allowing for direct substitution.

MODEL IDENTIFICATION CODE

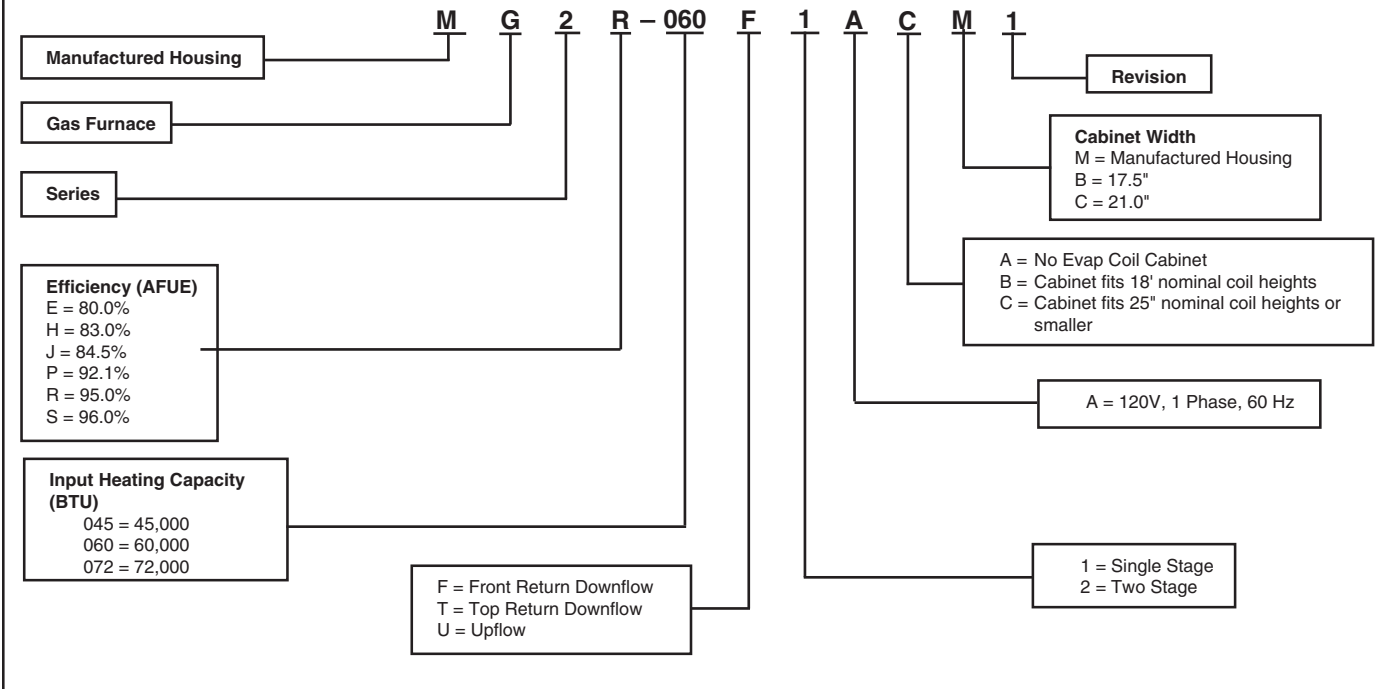

FEATURES

High Efficiency Downflow 95% AFUE Gas Furnace

Components

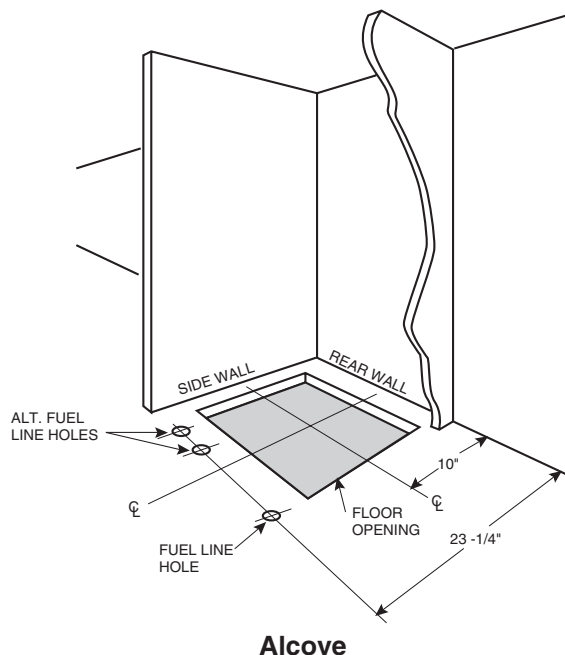
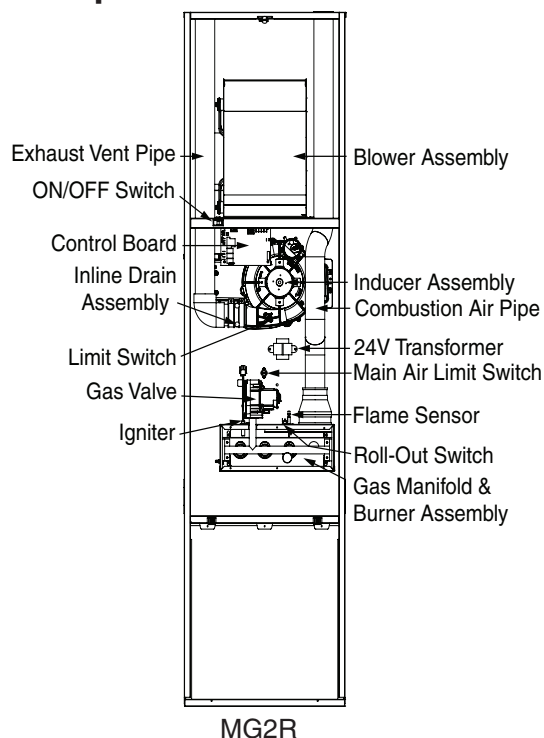

STANDARD EQUIPMENT

Direct vent; draft inducer; pressure switch; redundant main gas control; hot-surface ignition; timed ON/OFF blower controls (TDR); 40VA transformer for air conditioner application; limit controls; direct drive motor; all models can be converted to use LP (propane) gas.

Shipping Weights

Furnace Model	Shipping Weight (lbs)
MG2R 045***AM*	150
MG2R 045***CM*	170
MG2R 060***AM*	150
MG2R 060***CM*	170
MG2R 072***AM*	155
MG2R 072***CM*	175

*May include suffix - T

SPECIFICATIONS

MG2R MODEL NUMBERS:	045F	045T	060F	060T	072F	072T
Input (BTUH)*	45000	45000	60000	60000	72000	72000
Heating Capacity (BTUH)	42750	42750	57000	57000	68400	68400
AFUE (%)	95	95	95	95	95	95
Motor FLA (Amps)	8.4	8.4	8.4	8.4	8.4	8.4
Rated Ext. SP (in. WC)	0.3	0.3	0.3	0.3	0.3	0.3
Temperature Rise Range (°F)	35-65	25-55	35-65	25-55	35-65	35-65
Fuse or Breaker (Amps)	20	20	20	20	20	20

Note: All models are 115V, 60 Hz, 1 phase. Gas Connections are 1/2" NPT. AFUE = Annual Fuel Utilization Efficiency
 * Ratings to 2,000 ft. Over 2,000 ft. reduce 4% for each 1,000 ft. above sea level.

DIMENSIONS

Top

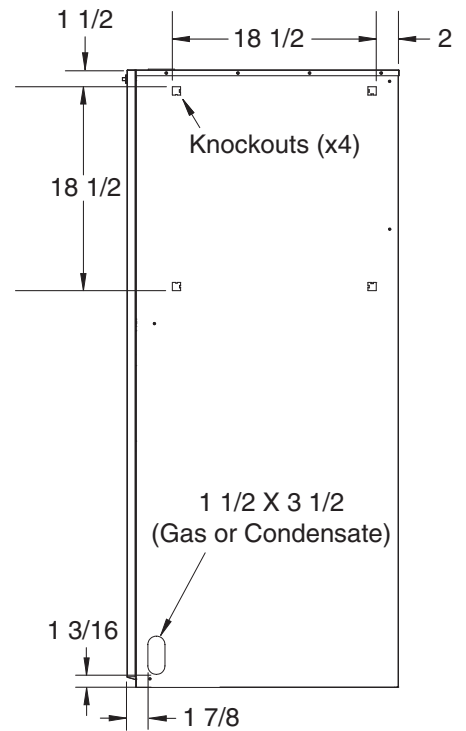
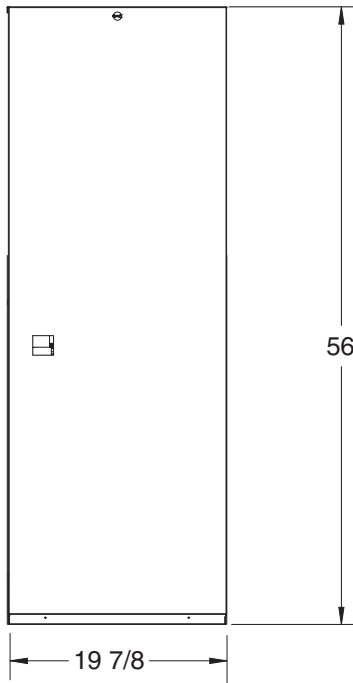
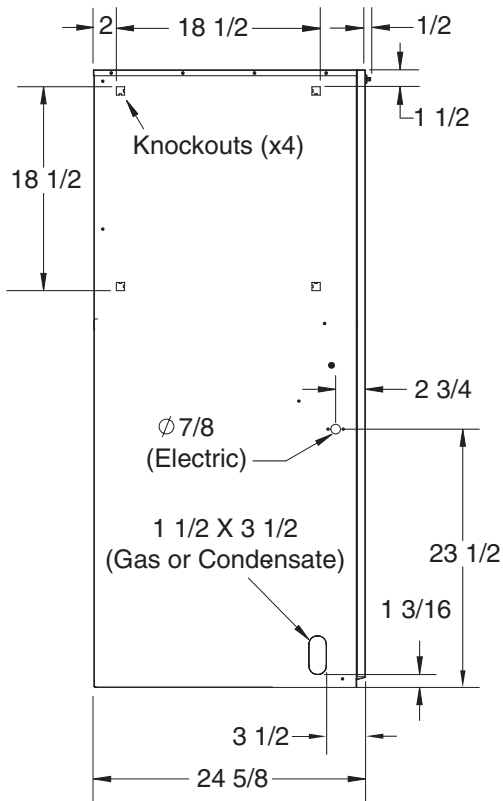
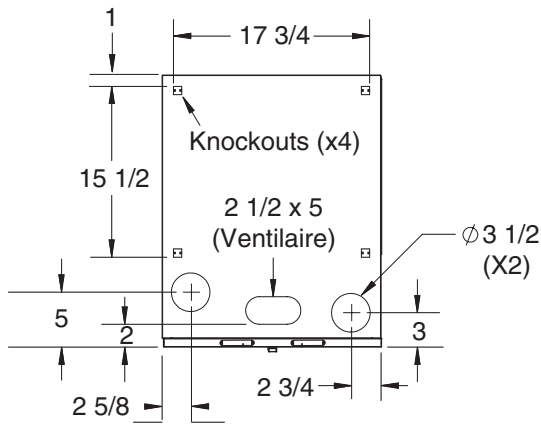

1 1/2 X 3 1/2
(Gas or Condensate - Typical)

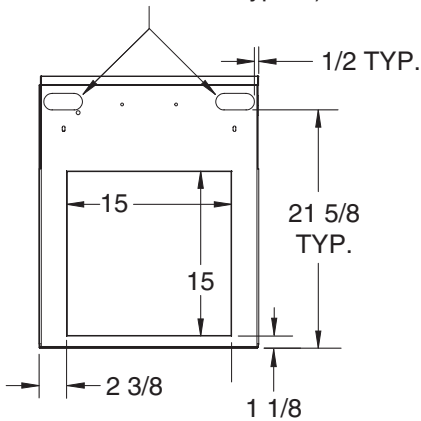

ALL MODELS	CLOSET	ALCOVE
	Inches	Inches
Front	1*	1*
Back	0	0
Sides	0	0
Vent	0	0
Top	6	6
Duct (Plenum) w/ Coil Box	0	0
w/o Coil Box (within 3 feet)	1/4	1/4

*Note: For 1" clearance, use a fully louvered door with at least 400 square inches of free airflow area.

Minimum Clearances

F**AM Models

Top

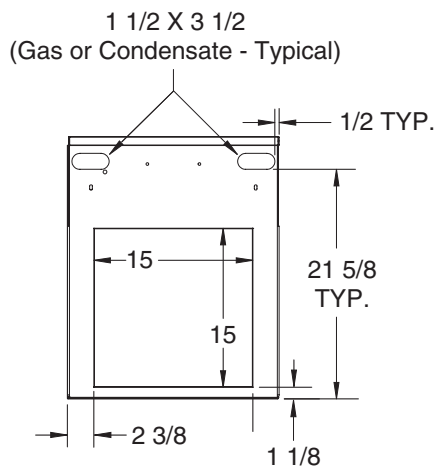
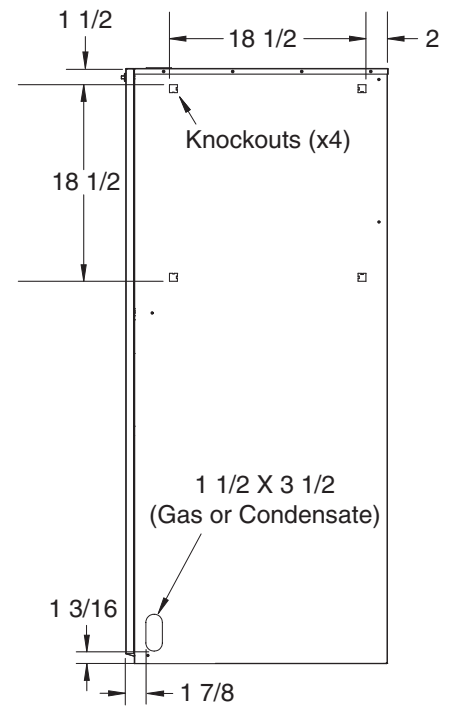
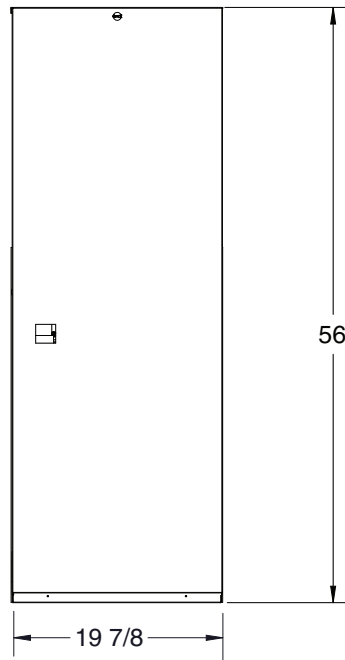
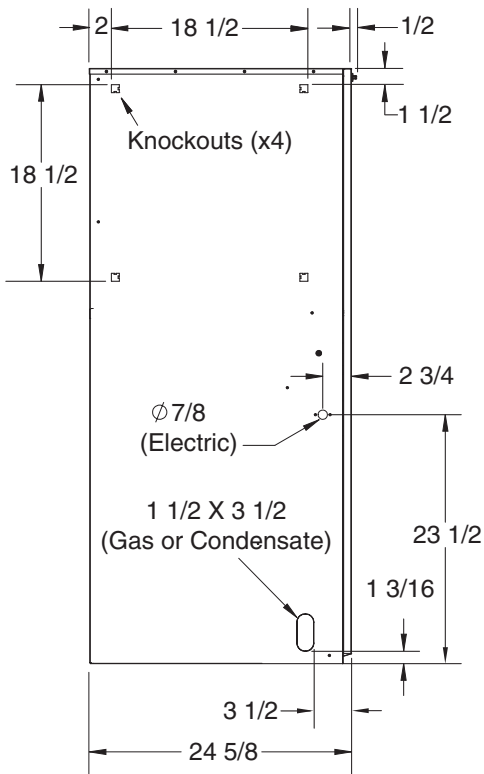
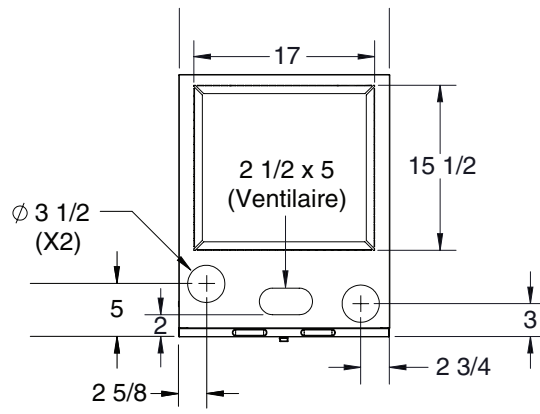

T**AM Models

DIMENSIONS

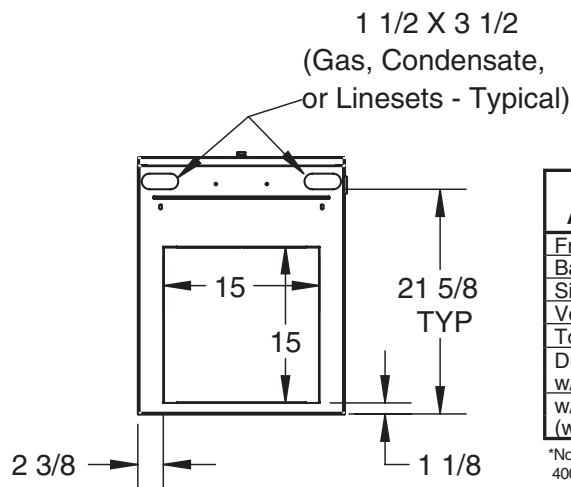
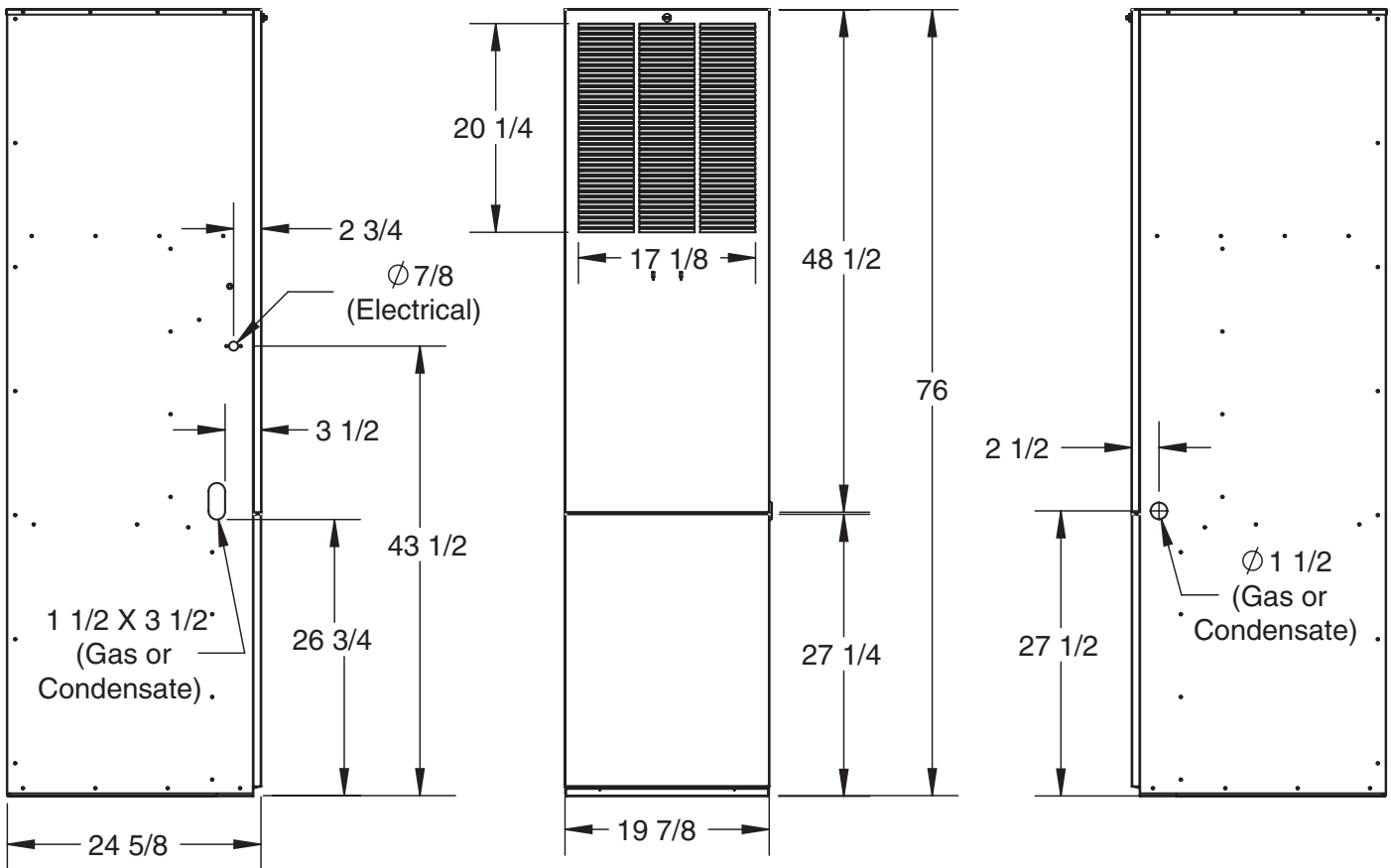
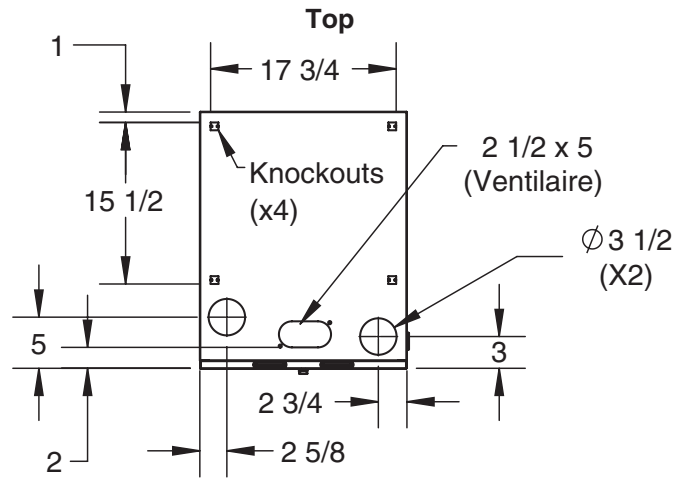

ALL MODELS	CLOSET	ALCOVE
	Inches	Inches
Front	1*	1*
Back	0	0
Sides	0	0
Vent	0	0
Top	6	6
Duct (Plenum) w/ Coil Box	0	0
w/o Coil Box (within 3 feet)	1/4	1/4

*Note: For 1" clearance, use a fully louvered door with at least 400 square inches of free airflow area.

Minimum Clearances

F**CM Models

DIMENSIONS

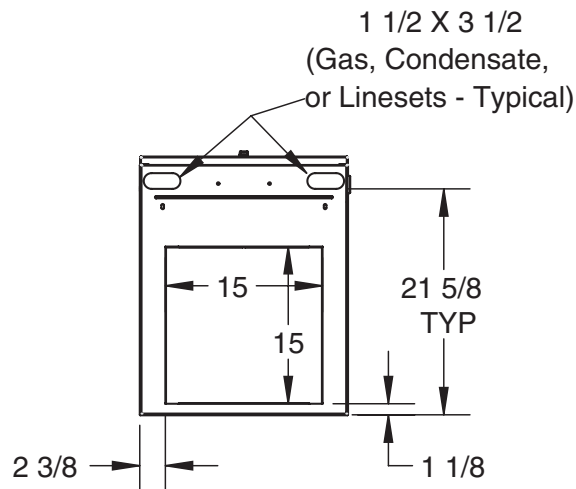
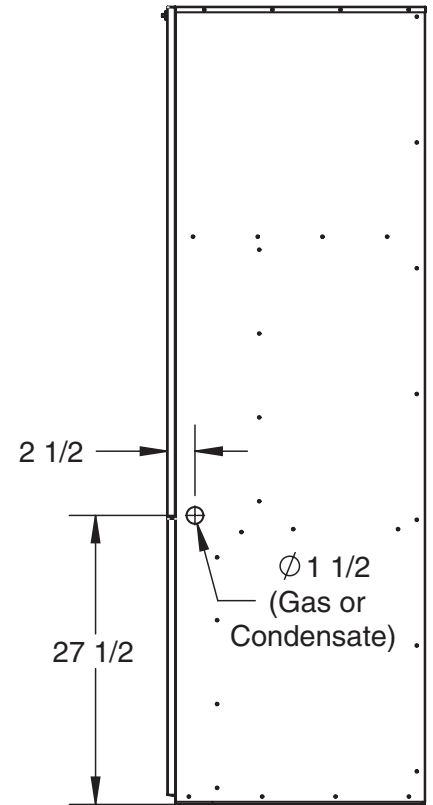
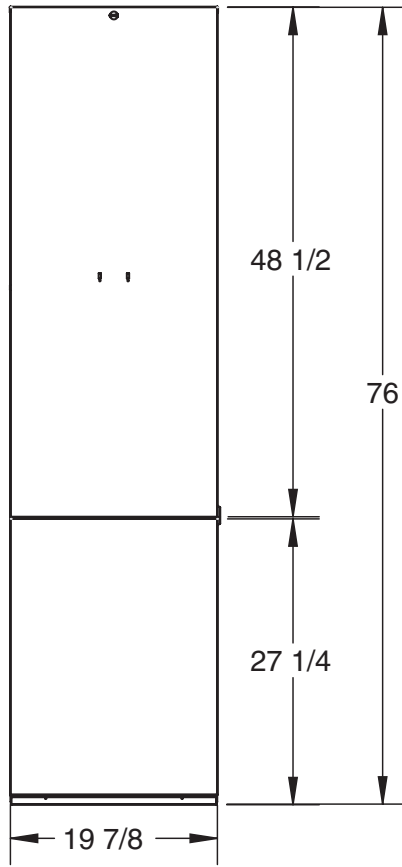
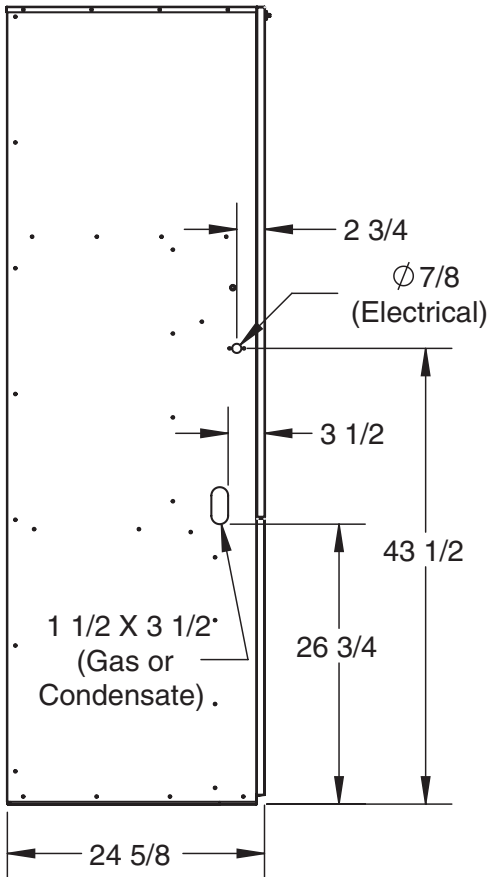
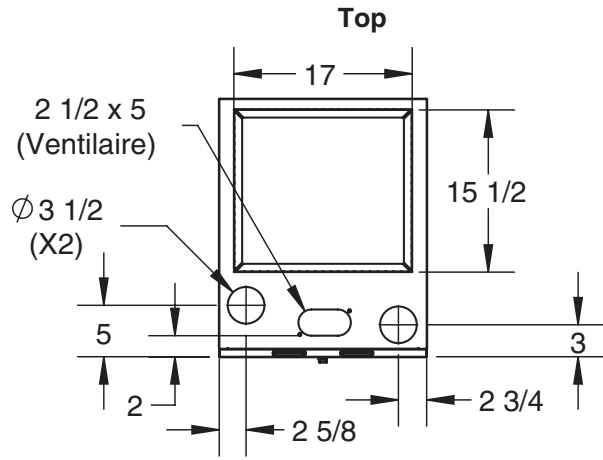

TCM Models**

BLOWER PERFORMANCE - FRONT RETURN HEATING

		Heating Airflow (CFM) & Temperature Rise (°F)									
Model Number & Heating Input (BTUH)	Motor Speed	External Static Pressure (Inches Water Column)									
		0.1		0.2		0.3		0.4		0.5	
		CFM	Rise	CFM	Rise	CFM	Rise	CFM	Rise	CFM	Rise
MG2R 045F 45,000 BTU/Hr	5 - High										
	4 - Med-High										
	3 - Medium										
	2 - Med-Low			927	36	867	38	811	41	750	44
	1 - Low	757	44	669	50	618	54	546	61		
MG2R 060F 60,000 BTU/Hr	5 - High										
	4 - Med-High										
	3 - Medium	1,242	36	1,196	37	1,156	38	1,111	40	1,069	42
	2 - Med-Low	950	47	903	49	857	52	806	55	741	60
	1 - Low	757	59								
MG2R-072F 72,000 BTU/Hr	5 - High										
	4 - Med-High										
	3 - Medium	1,276	42	1,232	43	1,191	45	1,151	46	1,103	48
	2 - Med-Low	1,124	47	1,084	49	1,028	52	980	54	930	57
	1 - Low										

NOTES:

1. Data is shown without filter.
2. Temperature rises in the table are approximate. Actual temperature rises may vary.
3. Individual cells shaded in gray indicate a temperature rise outside of the recommended range.
4. To comply with government mandated efficiency standards, speed settings shaded in gray are not allowed in HEAT mode.
5. The "*" denotes the factory heat setting and "*" denotes the factory cool setting. If the Alternate speed is to be used, the speed tap must be adjusted at the blower motor plug.

BLOWER PERFORMANCE - FRONT RETURN COOLING

		Cooling Airflow (CFM)							
Model Number & Heating Input (BTUH)	Motor Speed	External Static Pressure (Inches Water Column)							
		0.1	0.2	0.3	0.4	0.5	0.6	0.7	0.8
		CFM	CFM	CFM	CFM	CFM	CFM	CFM	CFM
MG2R 045F 45,000 BTU/Hr	5 - High	1,605	1,565	1,524	1,489	1,452	1,416	1,381	1,341
	4 - Med-High	1,381	1,337	1,293	1,248	1,204	1,160	1,114	1,062
	3 - Medium	1,278	1,234	1,192	1,150	1,111	1,057	997	941
	2 - Med-Low	978	927	867	811	750	698	639	595
	1 - Low	757	669	618	546	502	476	447	432
MG2R 060F 60,000 BTU/Hr	5 - High	1,614	1,570	1,533	1,499	1,463	1,421	1,385	1,347
	4 - Med-High	1,409	1,365	1,326	1,285	1,242	1,198	1,147	1,095
	3 - Medium	1,242	1,196	1,156	1,111	1,069	1,016	953	902
	2 - Med-Low	950	903	857	806	741	686	641	601
	1 - Low	757	669	618	546	502	476	447	432
MG2R-072F 72,000 BTU/Hr	5 - High	1,560	1,523	1,484	1,445	1,407	1,367	1,329	1,290
	4 - Med-High	1,443	1,400	1,354	1,311	1,264	1,220	1,175	1,132
	3 - Medium	1,276	1,232	1,191	1,151	1,103	1,055	1,006	962
	2 - Med-Low	1,124	1,084	1,028	980	930	875	823	778
	1 - Low	717	647	603	512	433	375	307	244

NOTES:

1. Data is shown without filter.

BLOWER PERFORMANCE - TOP RETURN HEATING

Heating Airflow (CFM) & Temperature Rise (°F)											
Model Number & Heating Input (BTUH)	Motor Speed	External Static Pressure (Inches Water Column)									
		0.1		0.2		0.3		0.4		0.5	
		CFM	Rise	CFM	Rise	CFM	Rise	CFM	Rise	CFM	Rise
"MG2R 045T 45,000 BTU/Hr"	5 - High**										
	4 - Alternate										
	3 - Med-High*	1,207	28	1,157	29	1,107	30	1,061	31	1,018	33
	2 - Med-Low	1,122	30	1,059	31	1,011	33	967	34	930	36
	1 - Low	904	37	828	40	765	44	718	46	665	50
"MG2R 060T 60,000 BTU/Hr"	5 - High										
	4 - Med-High										
	3 - Medium	1,228	36	1,181	38	1,131	39	1,085	41	1,040	43
	2 - Med-Low	1,122	40	1,059	42	1,011	44	967	46	930	48
	1 - Low	904	49	828	54						
"MG2R 072T 72,000 BTU/Hr"	5 - High**										
	4 - Med-High*					1,545	35	1,505	35	1,464	36
	3 - Alternate	1,432	37	1,385	39	1,349	40	1,305	41	1,268	42
	2 - Med-Low	1,309	41	1,262	42	1,217	44	1,169	46	1,128	47
	1 - Low	1,014	53	954	56	909	59	854	62		

NOTES:

1. Data is shown without filter.
2. Temperature rises in the table are approximate. Actual temperature rises may vary.
3. Individual cells shaded in gray indicate a temperature rise outside of the recommended range.
4. To comply with government mandated efficiency standards, speed settings shaded in gray are not allowed in HEAT mode.
5. The "*" denotes the factory heat setting and "**" denotes the factory cool setting. If the Alternate speed is to be used, the speed tap must be adjusted at the blower motor plug.

BLOWER PERFORMANCE - TOP RETURN COOLING

Cooling Airflow (CFM)										
Model Number & Heating Input (BTUH)	Motor Speed	External Static Pressure (Inches Water Column)								
		0.1	0.2	0.3	0.4	0.5	0.6	0.7	0.8	
		CFM	CFM	CFM	CFM	CFM	CFM	CFM	CFM	
"MG2R 045T 45,000 BTU/Hr"	5 - High**	1,718	1,678	1,636	1,594	1,553	1,512	1,477	1,434	
	4 - Alternate	1,441	1,394	1,352	1,309	1,264	1,222	1,179	1,133	
	3 - Med-High*	1,207	1,157	1,107	1,061	1,018	977	928	865	
	2 - Med-Low	1,122	1,059	1,011	967	930	877	827	741	
	1 - Low	904	828	765	718	665	582	531	482	
MG2R 060T 60,000 BTU/Hr	5 - High	1,718	1,678	1,636	1,594	1,553	1,512	1,477	1,434	
	4 - Med-High	1,441	1,394	1,352	1,309	1,264	1,222	1,179	1,133	
	3 - Medium	1,228	1,181	1,131	1,085	1,040	1,002	953	896	
	2 - Med-Low	1,122	1,059	1,011	967	930	877	827	741	
	1 - Low	904	828	765	718	665	582	531	482	
"MG2R 072T 72,000 BTU/Hr"	5 - High**	1,806	1,775	1,732	1,692	1,650	1,609	1,574	1,532	
	4 - Med-High*	1,623	1,584	1,545	1,505	1,464	1,420	1,378	1,339	
	3 - Alternate	1,432	1,385	1,349	1,305	1,268	1,221	1,180	1,129	
	2 - Med-Low	1,309	1,262	1,217	1,169	1,128	1,093	1,033	983	
	1 - Low	1,014	954	909	854	798	715	657	592	

NOTES:

1. Data is shown without filter.

ACCESSORIES

Description	Part Number
Automatic Cavity Damper	901083
"VEE" Box Adapters (12") - 5 / carton	902149
A/C Coil Box 20"	911969A
A/C Coil Box 24"	922594
Concentric Vent Termination Kit 3" U.S. Canadian Approved (for horizontal and vertical venting)	904953
Concentric Vent Termination Kit 2" U.S. Canadian Approved (for horizontal and vertical venting)	904952
Neutralizer Kit - All Models	902377
PVC Isolation Kit	904063
Vent Transition Kit	904106

ACCESSORY VENT KITS

Fresh Air and Vent Kits	Part Number
Soffit Air Inlet (for VentilAire III only)	917201
VentilAire III - Sloped 3/12	914098
VentilAire IV - Sloped 3/12	914229
VentilAire V - Sloped 3/12	1018547

Duct Connectors	Part Number
11.25 x 13.50 x 0.88 12 / carton	901987A
11.25 x 13.50 x 2.00 12 / carton	901988A
11.25 x 13.50 x 4.25 6 / carton	901989A
11.25 x 13.50 x 6.25 6 / carton	901990A
11.25 x 13.50 x 8.25 4 / carton	901991A
11.25 x 13.50 x 10.25 3 / carton	901992A
11.25 x 13.50 x 12.25 3 / carton	901993A
11.25 x 13.50 x 6.25 24 / carton	902681A

VENTING

All models are approved for both vertical and horizontal direct (2 pipe) venting applications. See Vent Table below for specified sizes and allowable lengths.

Maximum Direct Vent, Dual Pipe Length (ft.)*		
M7RL Inputs (BTUH)	Inlet / Outlet 3 in. Diameter	Inlet / Outlet 2 in. Diameter
45,000	60	30
60,000	60	30
72,000	60	30

***NOTES:**

1. Subtract 3.5 ft. for each additional 3" 90 degree elbow.
2. Two 45 degree elbows are equivalent to one 90 degree elbow.
3. One short radius elbow is equivalent to two long radius elbows
4. Do not include termination elbows in calculation of vent length
5. This table is applicable for elevations from sea level to 2,000 ft.
For higher elevations decrease vent pipe lengths by 8% per 1000 ft. of altitude.
6. Only the listed pipe materials are approved for use with M7 condensing furnaces.
7. For Canadian applications, use ULC S636 approved material.

Pipe Materials	ANSI/ASTM Standard
Schedule 40PVC	D1785
PVC-DWV	D2665
SDR-21 & SDR-26	D2241
ABS-DWV	D2661
Schedule 40 ABS	F628



GENERAL TERMS OF LIMITED WARRANTY

For complete details of the Limited Warranty, including applicable terms and conditions, see your local installer or contact the Nortek Global HVAC, LLC warranty department for a copy.

Before purchasing this appliance, read important energy cost and efficiency information available from your retailer. Specifications and illustrations subject to change without notice and without incurring obligations. Printed in U.S.A (12/23)